

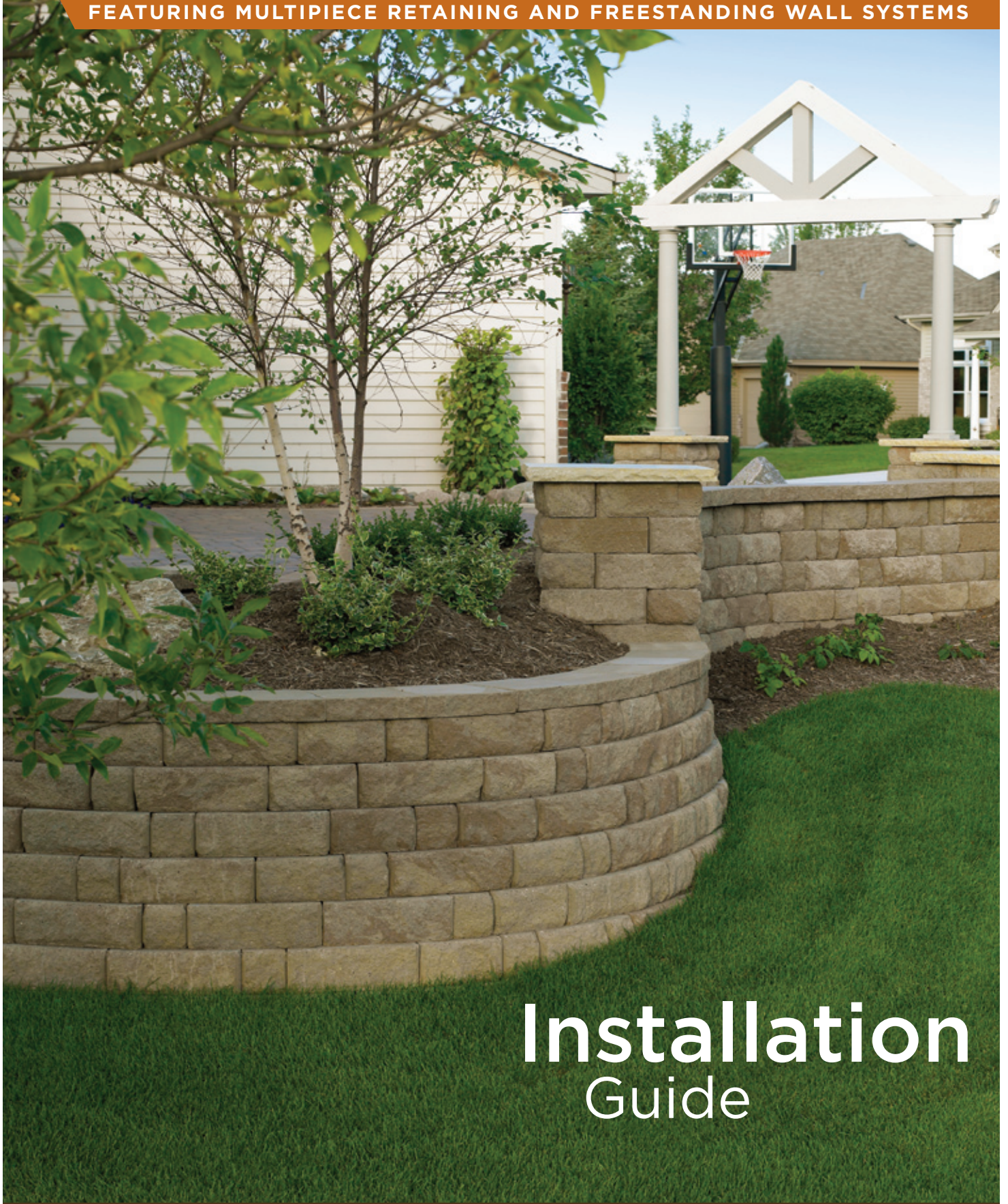

ANCHOR[®]
BUILD SOMETHING BEAUTIFUL



FEATURING MULTIPIECE RETAINING AND FREESTANDING WALL SYSTEMS



Installation Guide

Table of Contents and How to Use This Guide

TABLE OF CONTENTS

| | |
|---|----|
| HOW TO USE THIS GUIDE | 2 |
| BEFORE YOU BEGIN | 2 |
| RETAINING WALL BASICS | 3 |
| INSTALLATION INSTRUCTIONS FOR MULTIPIECE FREESTANDING WALL SYSTEMS | 4 |
| CONSTRUCTION DETAILS FOR MULTIPIECE FREESTANDING WALL SYSTEMS | 6 |
| RETAINING WALL INSTALLATION INSTRUCTIONS | |
| Best Practices | 8 |
| Wall Patterns for Multipiece Retaining Wall Systems | 10 |
| Stepping Up the Base | 11 |
| Abutting an Existing Structure | 11 |
| Capping a Wall | 12 |
| Capping a Pedestal | 12 |
| Daylighting Drainage | 13 |
| Drainage Swales | 13 |
| Steps in a 90° Wall | 14 |
| Steps in a Curved Wall | 15 |
| Outside Curves | 16 |
| Outside Curves with Reinforcement | 17 |
| Inside Curves | 18 |
| Inside Curves with Reinforcement | 18 |
| Outside 90° Corners | 19 |
| Outside 90° Corners with Reinforcement | 19 |
| Inside 90° Corners | 20 |
| Inside 90° Corners with Reinforcement | 21 |
| Water Applications | 22 |
| Terraces | 23 |
| Fences | 23 |

HOW TO USE THIS GUIDE

This guide is designed to provide you with ideas as well as information on product use and installation procedures. Because actual project conditions vary, final wall design, including the incorporation of geosynthetic reinforcement, must be performed by a qualified engineer. While this guide provides general guidelines, installation contractors should refer to construction drawings provided by a qualified local engineer for final specifications.

Additional installation information is available online at anchorwall.com. Information includes basic wall construction as well as other applications, including:

- freestanding walls
- cap placement
- various steps
- curves
- 90° corners
- water applications
- terraces

BEFORE YOU BEGIN

Advance planning and careful layout at the job site help ensure a successful retaining and freestanding wall project.

- Review the site plan to confirm lot lines, wall location, length and elevations.
- Understand on-site soils. Ideal soils are sand and gravel. For walls built in clay or poor soils, work with a local engineer to confirm the wall design and the required soil reinforcement. Black or organic soils should not be used as backfill.
- Confirm the location of underground utilities.
- Seek all necessary building permits.
- Prepare a drawing of the site with the wall location, lengths and elevations.
- Plan drainage to prevent erosion or buildup of water behind the wall. Consider where the water will drain through the wall, where downspouts will expel and whether there's an underground sprinkler. For walls greater than 3 feet in height, a perforated drainpipe is recommended at the base of the aggregate to quickly remove large amounts of water. See page 13 for more information on water management.
- Check the block delivered to ensure it is the correct color. Check the geosynthetic reinforcement to confirm that it's the strength and weight specified in the engineering plans.
- Be sure to use the right tools. Hand tools include a shovel, 4-foot level, dead-blow hammer, 2- or 3-pound hammer, chisel, hand tamper, hydraulic splitter and string line. Power tools include a circular saw with a masonry blade and a compactor.
- Always wear protective eyewear.

Segmental retaining walls typically fall into one of three categories.

GRAVITY RETAINING WALL

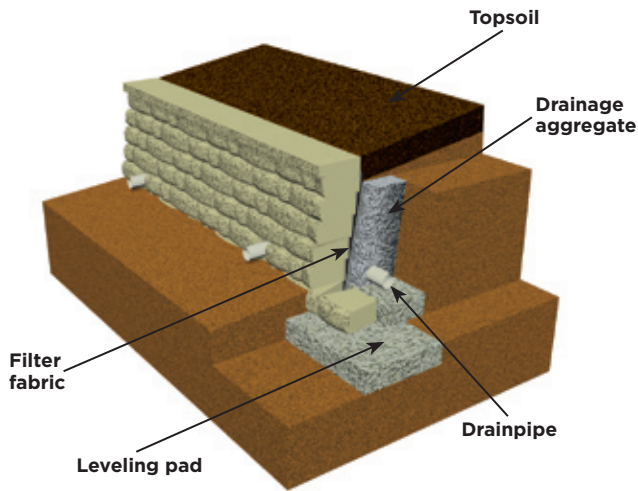

The first category - a gravity wall - is a retaining wall that does not use soil reinforcement. A gravity wall has height limitations specific to each product. An advantage of this type of retaining wall is that it requires a smaller work area behind the wall. A gravity wall relies on the weight and setback of the block to resist the soil forces being exerted on the wall.

GEOSYNTHETIC-REINFORCED RETAINING WALL

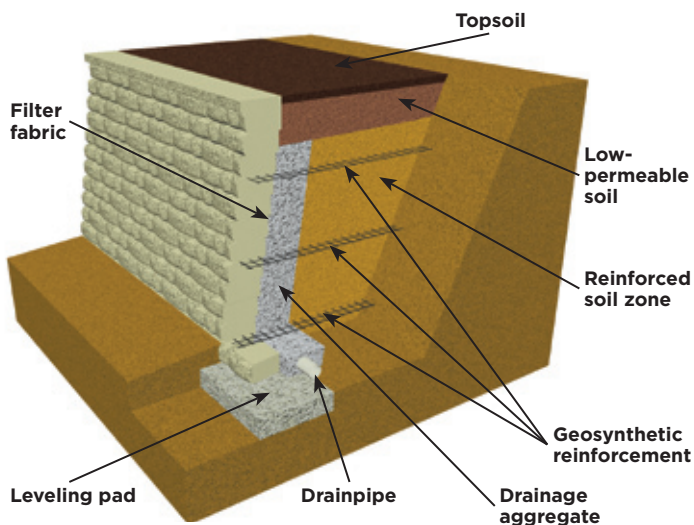

The second category is a geosynthetic-reinforced wall, which needs to be designed by a qualified engineer. There are (theoretically) no height limitations with reinforced retaining

walls, and they are used in larger applications. They require more work area behind the structure. The block of soil is stabilized by introducing reinforcement layers into the soil mass behind the facing units. The larger the stabilized soil mass, the more soil can be retained or held back. The geosynthetic reinforcement in the soil extends past the theoretical failure plane and serves to create a large, rectangular mass of block and soil, restraining the retained soil.

ANCHORPLEX™ RETAINING WALL SYSTEM

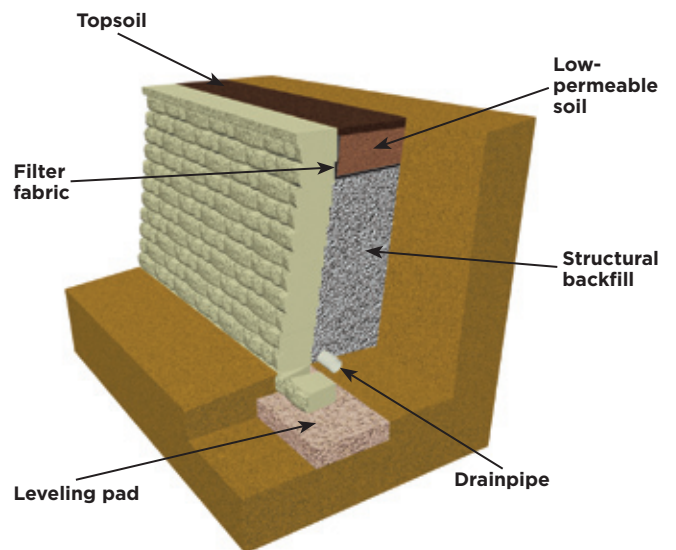

The third category is the Anchorplex™ retaining wall system, which offers a unique, nonconventional solution to problematic wall construction sites. It is a retaining wall built with Anchor™ products and self-compacting structural backfill specified by Anchor Wall Systems, and backed by engineering support tools developed by Anchor.

Use of the Anchorplex retaining wall system completely eliminates the need for the construction of a mechanically stabilized earth zone behind the wall facing and requires substantially less excavation than is usually necessary in grid-reinforced wall construction.

For more information about the Anchorplex retaining wall system, go to anchorwall.com.

Installation Instructions for Freestanding Wall Systems

PREPARE LEVELING PAD

Excavate for the leveling pad. The trench should be a minimum of 21 inches wide and should be 6 inches deeper than the block. *See Diagram 1.*

Create a leveling pad of compacted base material that extends a minimum of 6 inches in front of and 6 inches behind the wall units. This pad should also be at least 6 inches deep after compaction.

BASE COURSE

Once the pad is compact and level, begin placing the units. Center the units on the pad. The ends of the units should be in contact. The base course must be buried below grade and should be included when calculating total wall height. *See Diagram 2.*

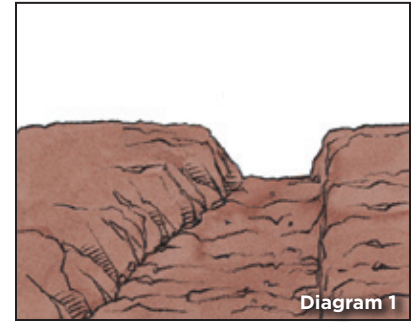

Diagram 1



Base course

It's easiest to build the base course for a straight wall out of large freestanding wall units.

BUILDING THE WALL

Units can be placed in any order to form an aesthetically pleasing layout. The simplest is one that incorporates large, medium and small units. The units should be installed so the ends are in complete contact with each other. Remember to keep the wall on bond by placing units in a staggered relationship to the course beneath. Repeat this process to complete the wall. Glue the top two courses and caps in place with a concrete adhesive.

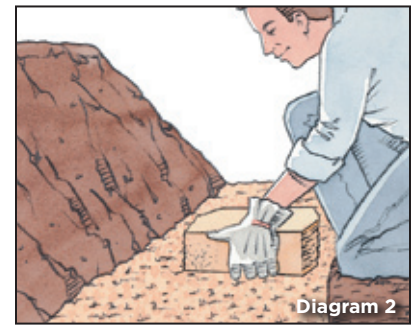

Diagram 2



Next course

ENDING A WALL

Split a large unit into pieces sized as needed. Do not use pieces smaller than 6 inches wide. If needed, cut the second-to-last piece and make the last piece the appropriate size. Smaller pieces should be glued into place with a concrete adhesive. After splitting the end piece, use a hammer and chisel to create a rounded appearance to match the manufactured split blocks.

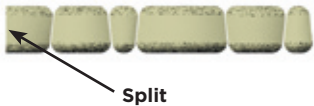

Wall end

CAPPING A WALL AND A PEDESTAL

See page 12 for details about cap installation.

INSTALLATION PATTERN

24-inch by 11-foot pattern

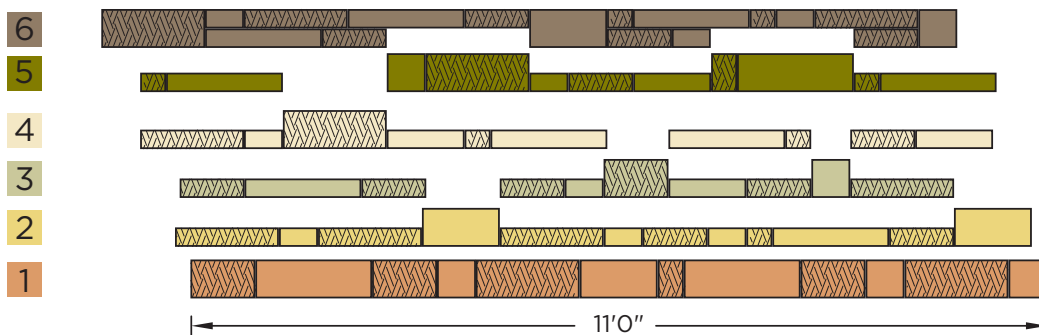

This pattern uses equal square feet of 3- and 6-inch product.

 Pattern indicates the shorter side of the block.

Installation Instructions for Freestanding Wall Systems

STRUCTURAL DESIGN ELEMENTS

Structural design elements must be used if a freestanding wall is more than 10 feet long. Structural design elements include

- curved walls
- freestanding wall jog
- 90° corner
- pedestals

CURVED WALLS

Add stability and a natural flow to walls with curves. While units can be turned somewhat, it may be necessary to make cuts with a concrete saw or splitter. As a rule, the smaller the units, the tighter the radius. Conversely, the larger the units, the larger the radius. Use approximately the same number of units for each course. The approximate minimum radius the system can turn, using all three pieces without cutting, is 3.75 feet measured to the outside face of the wall.

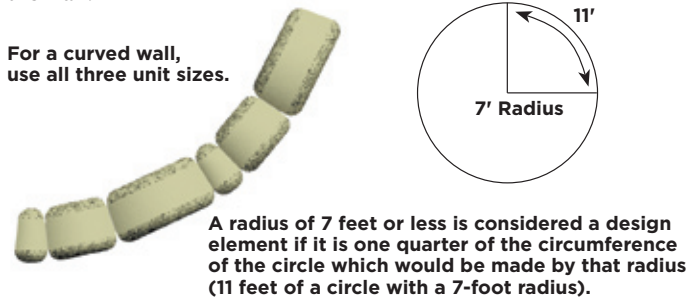

FREESTANDING WALL JOG

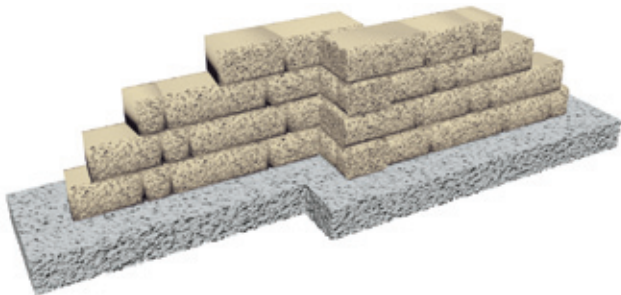

Jogs are used to break up straight lines and add stability to walls. Split units as needed. Use hammer and chisel to round split faces. Glue all courses of jog with a concrete adhesive.

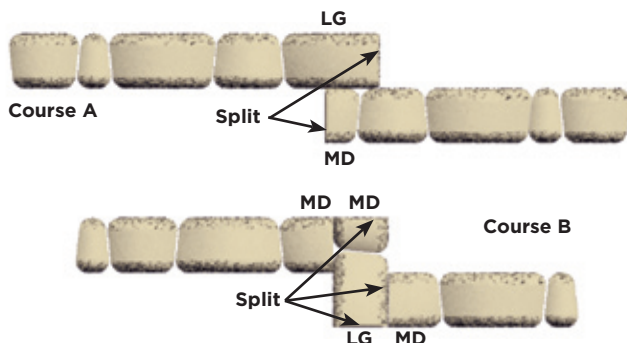

90° CORNER

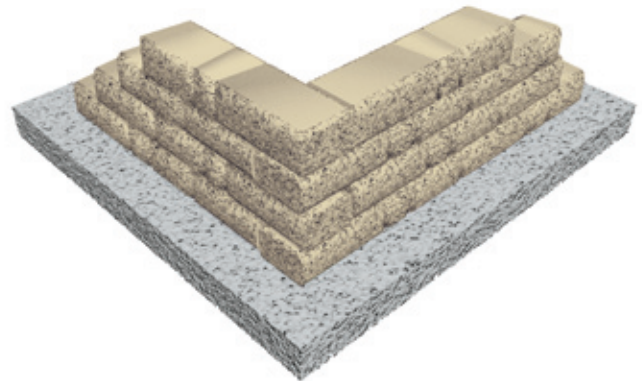

To create a 90° corner in a straight wall, make a third side to a large unit by splitting it to the appropriate dimension. Use only large units to assure connecting units are on bond. Alternate the direction the units face with each course. Round the split ends with a hammer and chisel. Glue all corner courses with a concrete adhesive.

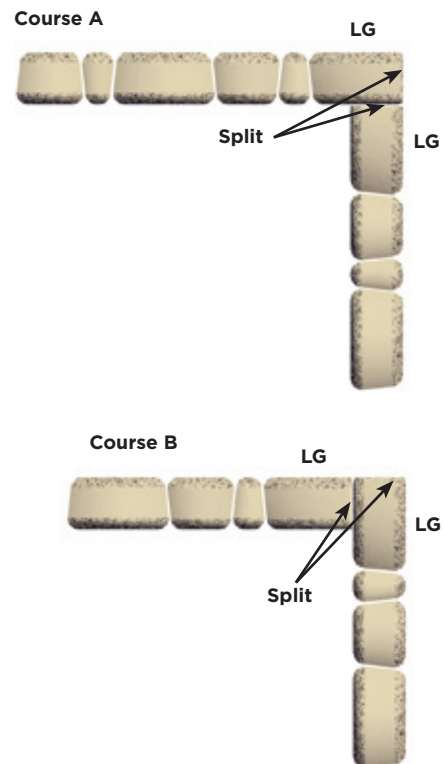

Construction Details for Multipiece Freestanding Wall Systems

PEDESTALS

When used with a freestanding wall, a pedestal increases wall stability. Placing fixtures on pedestals is also a great way to incorporate lighting. Pedestals can be located in the middle or at the end of a wall. The open space in the center of a pedestal permits reinforcement or electrical wiring if needed. The pedestal leveling pad should extend 6 inches beyond each pedestal edge and be at least 6 inches deep after compaction.

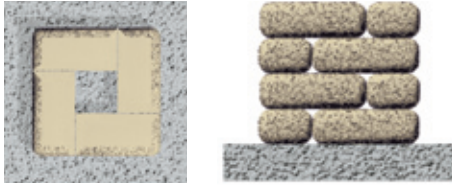

PEDESTAL AT END OF WALL—CENTERED

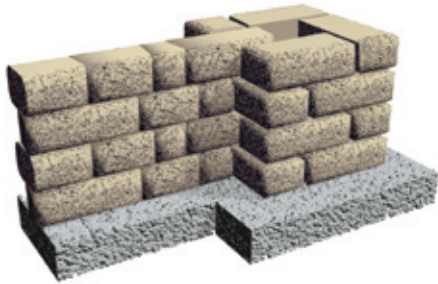

To build pedestals at the end of a wall, cut one pedestal unit in half for the second, fourth and additional even-numbered courses. Stack pedestal units in a rotating pattern for each course so that the bond is staggered. One pedestal unit half is used every two courses. Glue each course of pedestal units with a concrete adhesive. Integrate wall into pedestal as shown to increase stability.

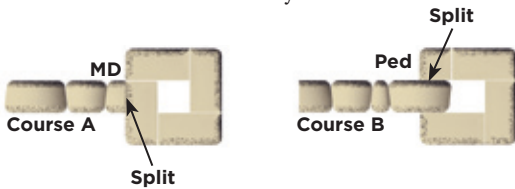

CAPPING A WALL AND A PEDESTAL

See page 12 for details about cap installation.

PEDESTAL AT END OF WALL—OFFSET

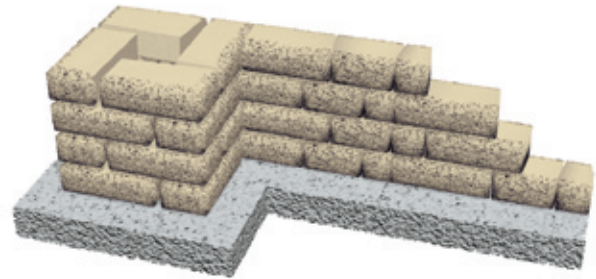

To build a pedestal at the end of a wall, stack three pedestal units as shown for the base course. For the second course, use pedestal units, stacking in a rotating pattern. Glue each course of units in the pedestal with concrete adhesive.

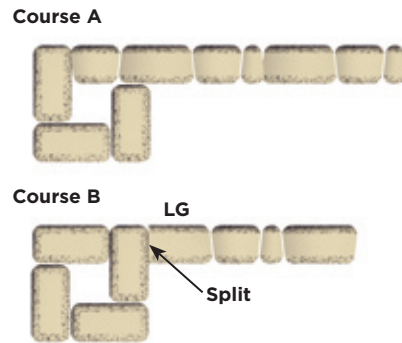

WALL THROUGH PEDESTAL

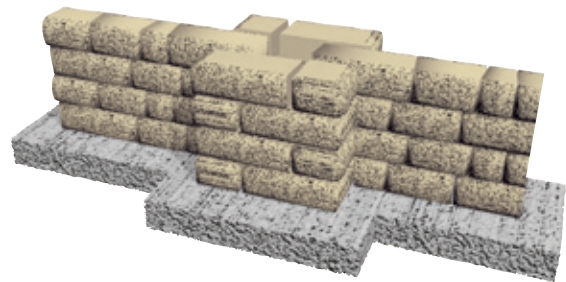

On the first course, use complete pedestal units to start the pedestal and cut the wall units to fit. On the second course, cut two pedestal units in half to fill in the corners. Continue construction by alternating courses. Glue all pedestal courses with a concrete adhesive.

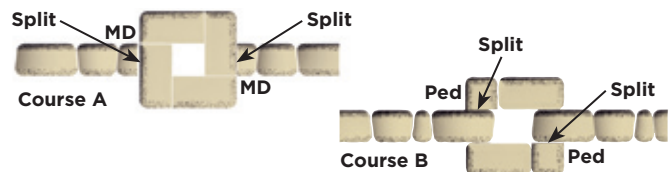

Construction Details for Multipiece Freestanding Wall Systems

PEDESTAL IN RUNNING WALL

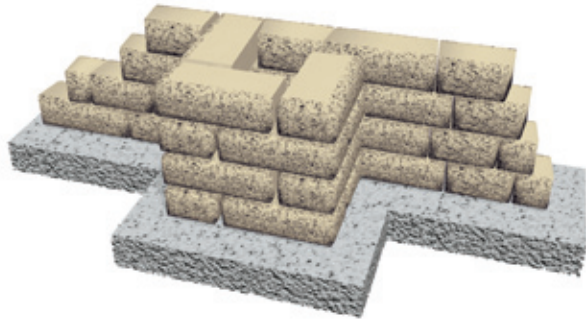

Pedestals add stability and elegance to a wall. They are located on one side of a wall. To build a pedestal, stack pedestal units in a rotating pattern for each course. Cut wall units as indicated. Glue each course of units in the pedestal with a concrete adhesive.

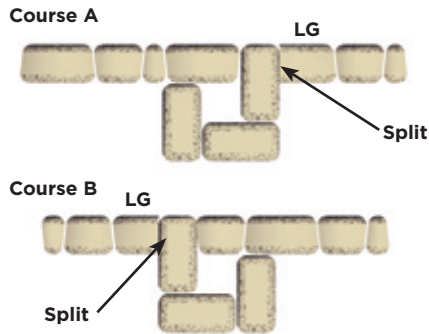

SMALL PEDESTAL IN WALL



There are times when a pedestal of a different size is needed. To build a smaller pedestal in the running wall, you will need to split a medium stretcher unit for the first course. Split it so that the pieces, combined with another medium unit, equal 18 inches. Place the units parallel to the wall on the prepared leveling pad. For the second course, split a large stretcher unit and a medium stretcher unit so that they equal 18 inches. Split a second set of large and medium units to make a second 18-inch section. Insert these units perpendicular to the wall as shown. Glue all courses. Round the split ends with a hammer and chisel.

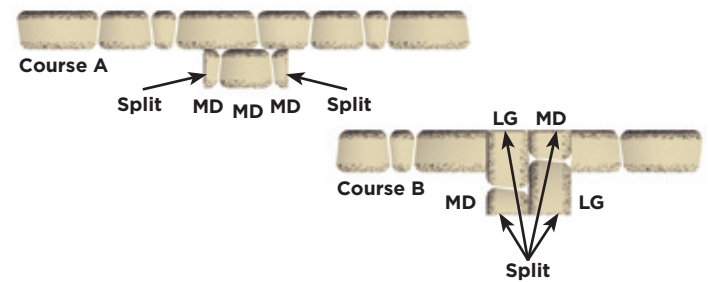

90° CORNER AT PEDESTAL



Frequently, a 90° turn is made at a pedestal. To build this pedestal, cut one pedestal unit per course. Stack pedestal units in a rotating pattern for each course. Glue each course of pedestal units with a concrete adhesive.

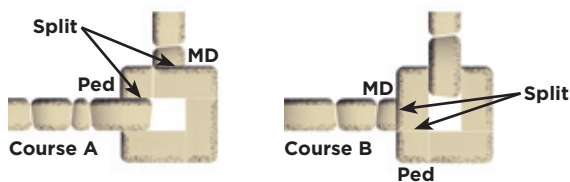

SMALL PEDESTAL AT END OF WALL

To build a smaller pedestal at the end of a running freestanding wall, you will need to split four stretcher units for the first course. Split a large and medium unit so they equal 18 inches. Split a second set of units to make a second 18-inch section. Insert the unit sets perpendicular to the wall on the prepared leveling pad.

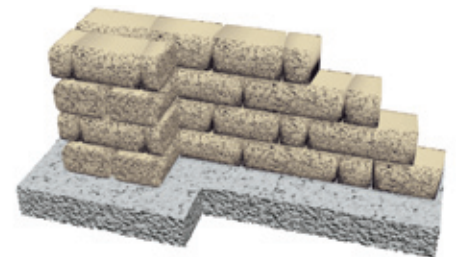

For the second course, center a medium stretcher unit over the base units as shown. Split another unit to maintain a staggered bond. Round the split ends with a hammer and chisel. Glue all units in the pedestal with a concrete adhesive.

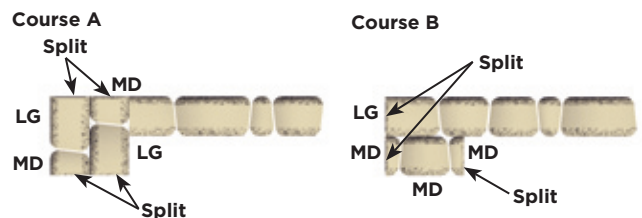

Retaining Wall Installation—Best Practices

STAKE OUT THE WALL

- Have a surveyor stake out the wall's placement. Verify the locations with the project supervisor.

EXCAVATION

- Excavate for the leveling pad to the lines and grades shown on the approved plans and excavate enough soil behind the wall for the geosynthetic reinforcement material, if needed. The trench for the leveling pad should be at least 12 inches wider than the block you are installing and 6 inches deeper than the height of the block. *See Diagram 1.*

LEVELING PAD

- An aggregate leveling pad is made of compactable base material of $\frac{3}{4}$ -inch minus (with fines).
- The pad must extend at least 6 inches in front of and behind the first course of block and be at least 6 inches deep after compaction.
- If the planned grade along the wall front will change elevation, the leveling pad may be stepped up in 6-inch increments to match the grade change. Start at the lowest level and work upward whenever possible.
- Compact the aggregate and make sure it's level front to back and side to side. Mist lightly with water before compaction. *See Diagram 2.*

BASE COURSE

- This is the most important step in the installation process. Bury the base course of block.
- Begin laying block at the lowest elevation of the wall. Remove the rear lip of the block by hitting from the back so that it will lie flat on the leveling pad.
- Place the first block level, front to back and side to side; lay subsequent blocks in the same manner.
- Place the blocks side by side, flush against each other, and make sure they are in full contact with the leveling pad.
- If the wall is on an incline, don't slope the blocks; step them up so they remain consistently level. (See page 11 for more information.)
- Use string line along the back edge of block to check for proper alignment.
- For multiple-piece products, use the largest unit, 18 inches wide, for the base course.

CONSTRUCTION OF SUBSEQUENT COURSES

- Clean any debris off the top of the blocks.
- You can install these products using any combination of blocks.
- Place the second course of blocks on top of the base course. Maintain running bond. Pull each block forward as far as possible to ensure the correct setback. *See Diagram 3.*
- For best results, use a filter fabric, which should be placed directly behind the wall extending from the bottom of the base course to the middle of the top course. This will minimize material coming through the rough-hewn face texture of these products. We recommend a non-woven, 4- to 6-ounce fabric. *See Diagram 4.*
- Backfill with drainage aggregate directly behind the block, adding 6 inches at a time followed by proper compaction.
- Add soil fill behind the aggregate. Compact before the next course is laid.
- Don't drive heavy equipment near the wall. Self-propelled compaction equipment should not be used within 4 feet of the wall.
- You may need partial units to stay on bond. A circular saw with a masonry blade is recommended for cutting partial units. Use safety glasses and other protective equipment when cutting.
- Keep the wall bond by placing units in a staggered relationship to the course beneath.

The following installation instructions apply to Anchor retaining wall products that feature a rear lip. Where there are variations, the appropriate information has been noted.

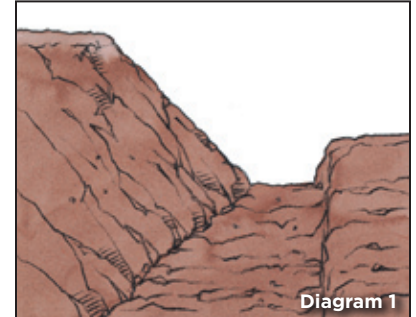

Excavation

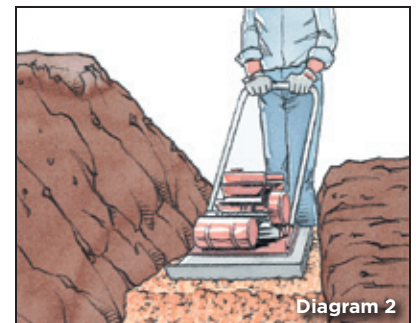

Leveling pad compaction

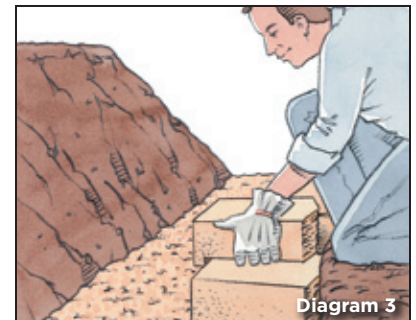

Construction of the next course

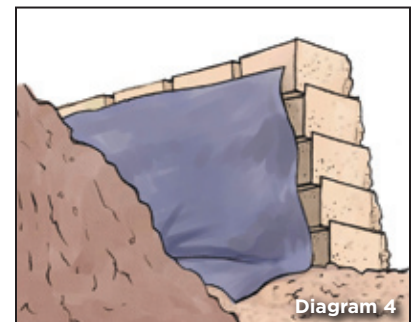

Filter fabric

Retaining Wall Installation—Best Practices

CAPPING

See page 12 for more information about cap installation.

DRAINAGE DESIGN

- Each project is unique. The grades on your site will determine at what level to install the drainpipe.
- Place the drainpipe as low as possible behind the wall so water drains down and away from the wall into a storm drain or to an area lower than the wall. *See Diagram 5.*
- Fill in the area behind the blocks with drainage aggregate, at least 12 inches from the wall.
- You may need to place and backfill several courses to achieve the proper drainage level.
- Cover the drainpipe with a geotextile sock which acts as a filter. The drainpipe outlets should be spaced not more than every 50 feet and at low points of the wall. In order for the drainage aggregate to function properly, it must keep clear of regular soil fill. (See page 13 for more information.)

COMPACTION

- Place the backfill soil behind the drainage aggregate and compact with a hand-operated compactor.
- Make sure the aggregate is level with or slightly below the top of the base course.
- Place soil in front of the base course and compact. The base course should be buried.
- Continue to fill and compact. *See Diagram 7.*

REINFORCEMENT (IF REQUIRED)

- Geosynthetic reinforcement is recommended for walls taller than gravity height walls situated in poor soils, supporting a driveway, etc. Consult a qualified engineer for design assistance.
- Check the wall construction plan for which courses will need reinforcement.
- Clean any debris off the top layer of blocks.
- Measure and cut the reinforcement to the design length in the plans.
- The reinforcement has a design strength direction, which must be laid perpendicular to the wall.
- Place the front edge of the material on the top course, 1 inch from the face of the block.
- Apply the next course of blocks to secure it in place.
- To keep it from wrinkling, pull the reinforcement taut and pin the back edge in place with stakes or staples.
- Add drainage aggregate behind the blocks, then add the soil and compact it. *See Diagrams 6 and 7.*
- Place the front edge of the reinforcement on top of the block, making sure it's within 1 inch of the face of the block. Correct placement ensures that you maximize the connection strength and keep the batter consistent.
- A minimum of 6 inches of backfill is required prior to operating vehicles on the reinforcement. Avoid sudden turning or braking. *See Diagram 7.*

FINISH GRADE AND SURFACE DRAINAGE

- Protect the wall with a finished grade at the top and bottom.
- To ensure proper water drainage away from the wall, use 6 inches of soil with low permeability. This will minimize water seeping into the soil and drainage aggregate behind the wall.

SITE CLEANING AND RESTORATION

- Brush off the wall and pick up any debris left from the construction process.
- Notify the job superintendent in writing of the project's completion and that it is ready for final inspection and acceptance.
- Planting vegetation in front and on top of the wall will help reduce the chance of erosion.
- Following these best practices for construction will ensure the successful installation of Anchor™ products.

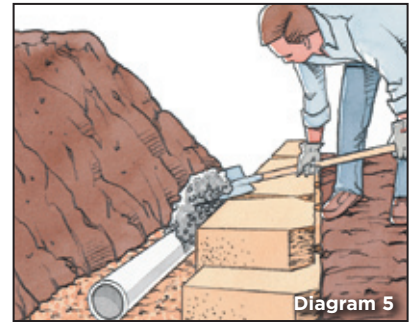

Drainpipe

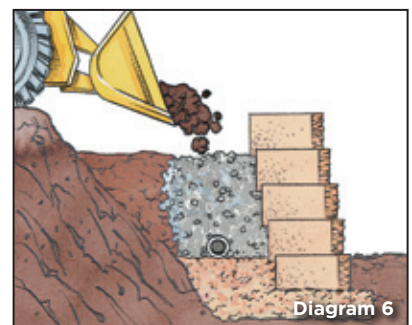

Drainage aggregate

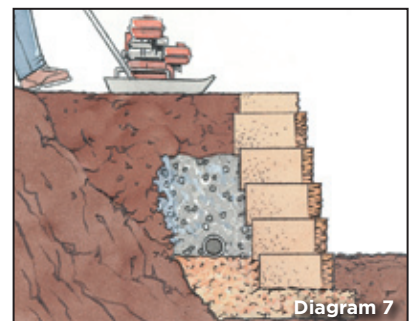

Compaction

SAFETY NOTE: Always use appropriate equipment, including safety glasses or goggles and respirators, when splitting, cutting or hammering units.



Wall Patterns for Multipiece Retaining Wall Systems

WHEN TO USE A PATTERN

You can install the multipiece retaining wall system in a random pattern using any combination of units. Just avoid vertical lines that span more than 1 foot in height. If you are building a wall without geosynthetic reinforcement, use a pattern for inspiration or follow a pattern exactly. Pleasing random patterns can be built using an equal number of 6- and 3-inch-high blocks or using an equal square footage of blocks in each size. These

patterns are based on using an equal number of blocks of each size in each height.

When building a wall that includes geosynthetic reinforcement, using a pattern at the appropriate spacing eliminates the need to cut the grid. When using a pattern, begin at one edge laying the blocks as indicated. Install at least one repeat of the pattern to establish the pattern before proceeding to the next course.

RANDOM-LOOK INSTALLATION PATTERNS

24-inch by 9-foot installation pattern

This illustrates a 24-inch-high by 9-foot-long repeating installation pattern. The installation pattern uses an equal number of units of each face size. When your plan requires reinforcement, this installation pattern is ideal because it eliminates cutting if the grid is at 24 inches.

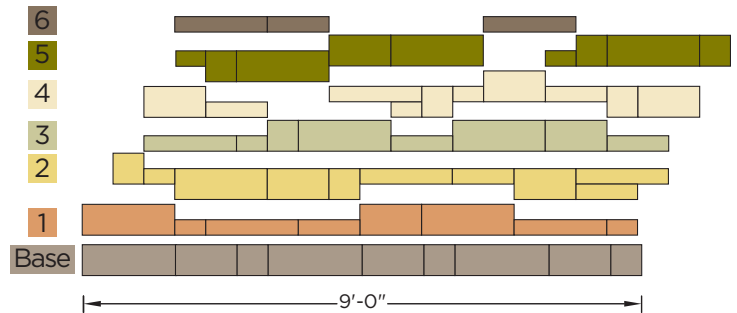

18-inch by 6-foot installation pattern

This illustrates an 18-inch-high by 6-foot-long repeating installation pattern. The installation pattern uses an equal number of units of each face size. When your plan requires reinforcement, this installation pattern is ideal because it eliminates cutting if the grid is at 18 inches.

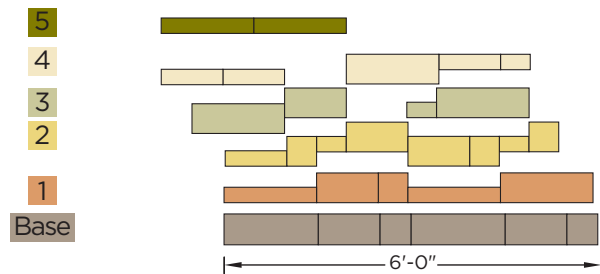

12-inch by 9-foot installation pattern

This illustrates a 12-inch-high by 9-foot-long repeating installation pattern. The installation pattern uses an equal number of units of each face size. When your plan requires reinforcement, this installation pattern is ideal because it eliminates cutting if the grid is at 12 inches.

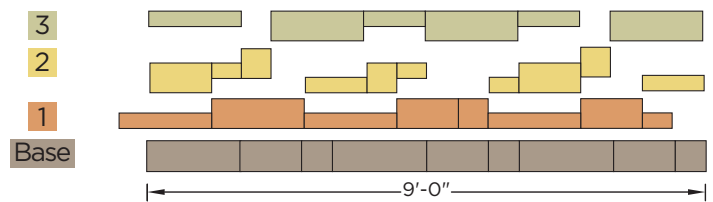

SEQUENT™ PANEL INSTALLATION PATTERN

27-inch by 6-foot installation pattern

This 27-inch-high by 6-foot-long installation pattern uses an equal number of units of each face size to make a panel. This installation pattern is one of many possible options. Others can be used for different appearances.

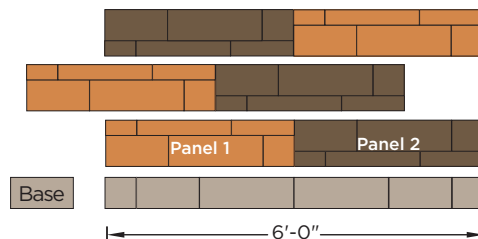

Stepping Up the Base and Abutting an Existing Structure

STEPPING UP THE BASE

LOWEST POINT

Walls built on a sloping grade require a stepped base. Begin excavation at the lowest point and dig a level trench into the slope until it is deep enough to accommodate the base material and one entire block.

STEP UP

At this point, step up the height of one block and begin a new section of base material. Continue to step up as needed to top of slope. Always bury at least one full unit at each step.

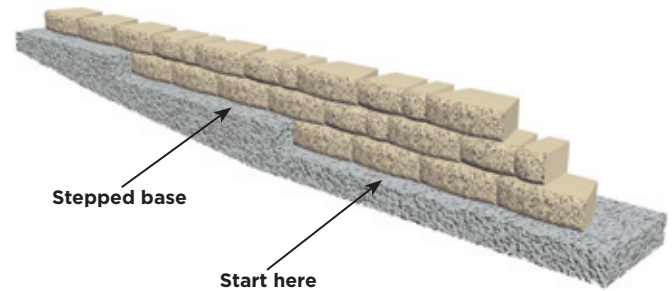

ABUTTING AN EXISTING STRUCTURE

FIRST COURSE

Begin with the first block next to the wall and place the first course. Place filter fabric behind the first two large units and extend it 2 feet along the existing structure.

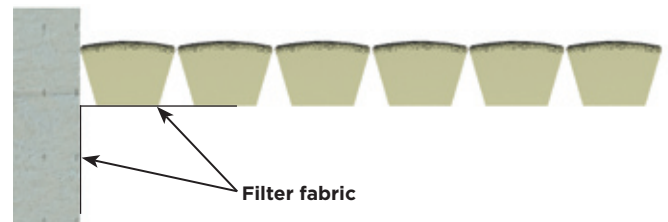

SECOND COURSE

Build the second course with standard installation techniques. A split unit is shown, but may not be necessary in every installation. Extend filter fabric to the top edge of the final course. A rubber membrane may be placed between the units and a non-concrete wall to prevent moisture damage to the structure.

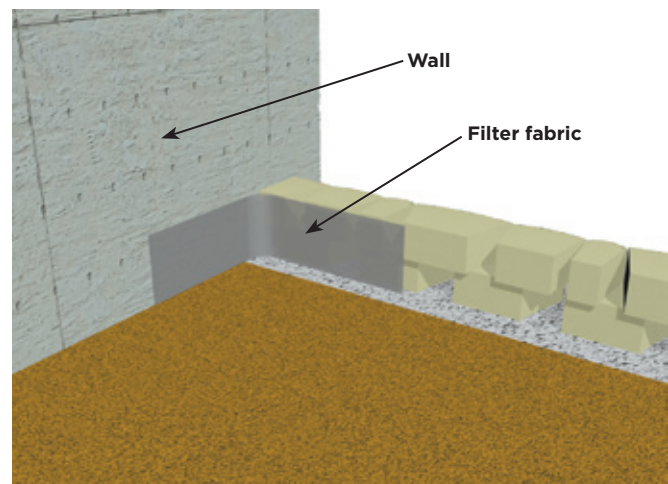
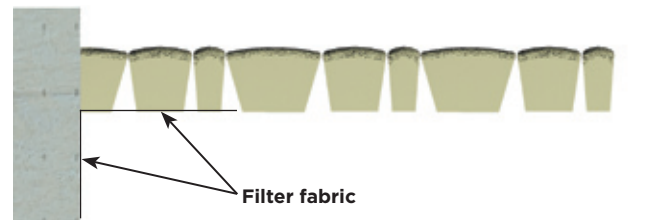

Capping a Wall and a Pedestal

STRAIGHT WALL

Trapezoidal caps must be laid alternately, short and long cap faces, for a straight line. Always start capping from the lowest elevation.

OUTSIDE CURVES

Lay out the cap units side by side and cut at least every other cap to produce a uniform look. Start with the long side of the cap facing out and adjust to the radius.

INSIDE CURVES

Lay cap units side by side with the short side facing out. In most circumstances, making two cuts on one cap and then not cutting the cap on either side produces the most pleasing look.

CORNERS

On a 90° corner wall, the corner caps need to be saw-cut to achieve a 45° mitered corner.

STEPPING UP CAPS

If a wall elevation changes, caps can be stacked where the wall steps up. Begin laying caps at the lowest elevation change and work your way back toward the previous step up. Split* a cap unit to fit. Place the split unit directly on top of the capped portion of the wall with all three split faces exposed.

FINISHING

After layout is complete and caps are saw-cut or split to size, carefully glue with a concrete adhesive.

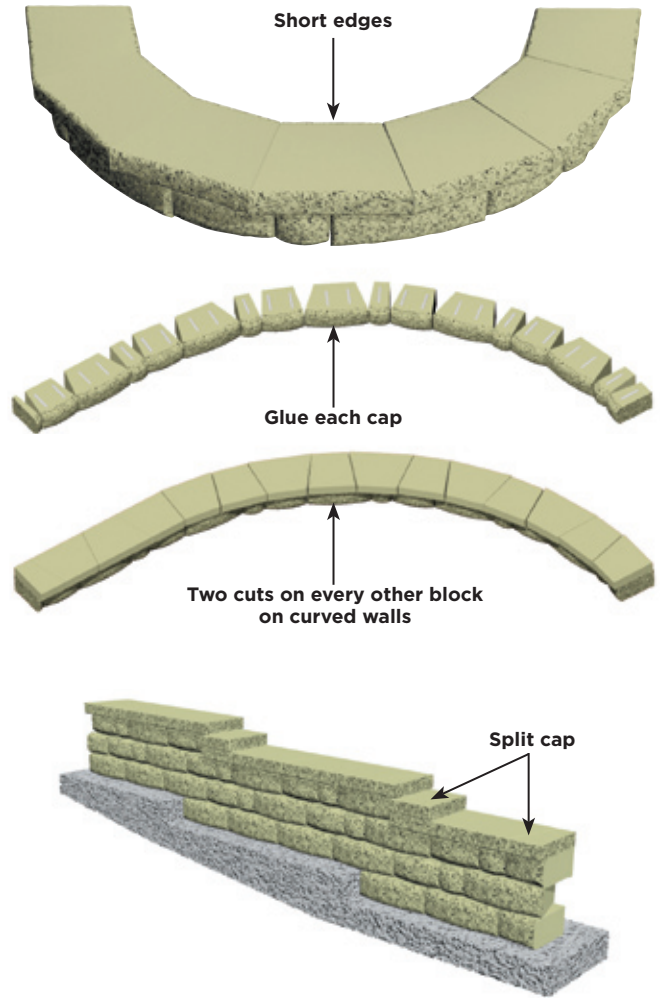

PEDESTAL

There are numerous ways to cap a pedestal. You can use cap units, single-piece units or natural stone.

Using an XL™ Cap—This capping treatment requires eight XL™ trapezoidal cap units. Each unit is cut as shown. Top with the 5-inch square coupon. Use concrete adhesive to glue all pieces when cap is complete.

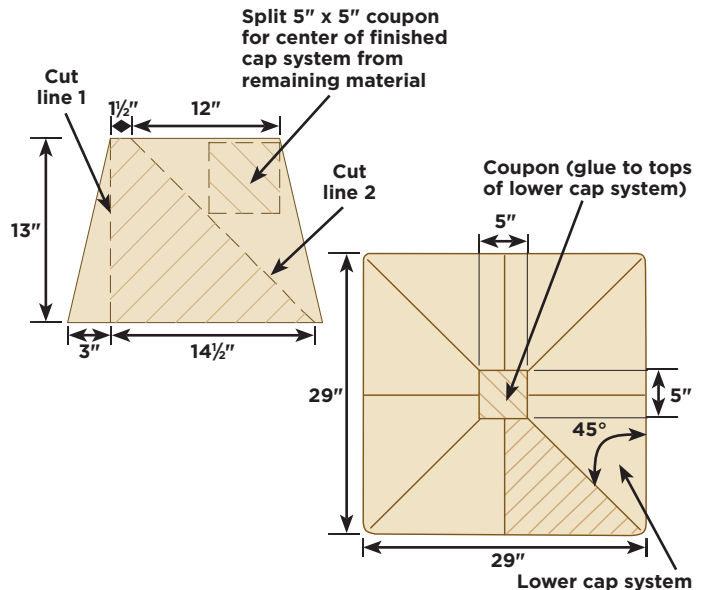

*To split a block, use a hydraulic splitter or split manually by using a hammer and chisel to score the block on all sides. Pound the chisel on the same line until the block splits. If partial unit sides are not exposed, use a circular cut-off saw with a masonry blade to achieve a tighter fit.

Daylighting Drainage and Drainage Swales

DAYLIGHTING DRAINAGE

FIRST COURSE

To daylight drainpipes through a wall face, put them on compacted leveling pad aggregate placed behind the first course. Space these drains not more than 50 feet apart. Split 2 inches off the front of two adjacent large units to provide space for the drainpipe to exit through the face.

SUBSEQUENT COURSES

Build this and remaining courses using standard construction techniques.

Tip: To daylight through slope, see Drainage Swales.

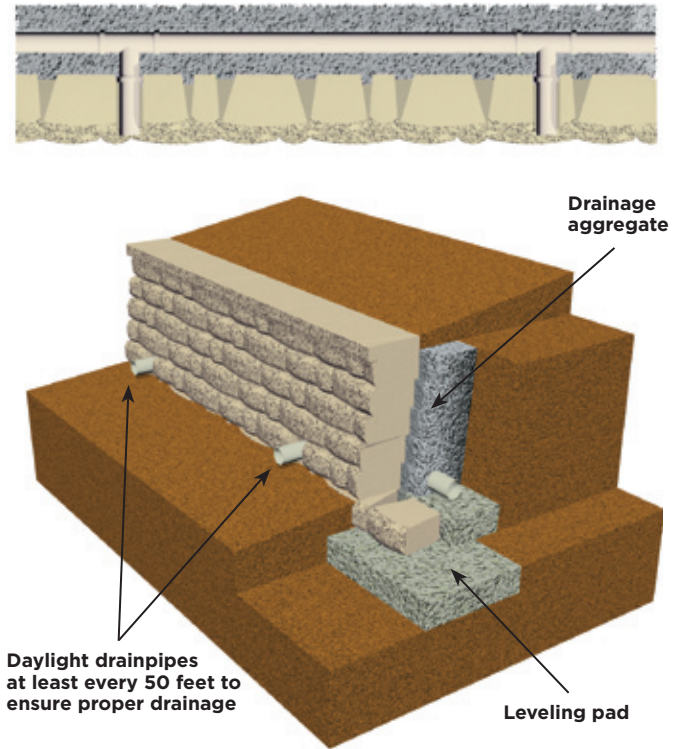

DRAINAGE SWALES

Design and performance of most retaining walls are based on keeping the reinforced zone relatively dry. Appropriate drainage swales to help control water should be designed into the wall construction plan.

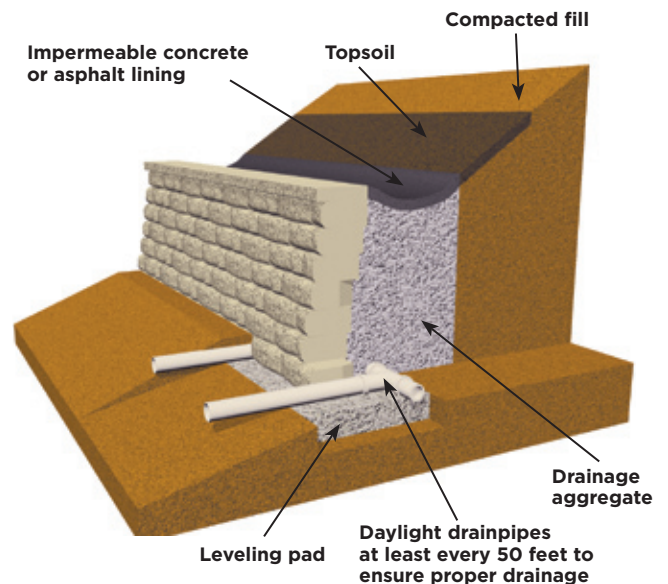
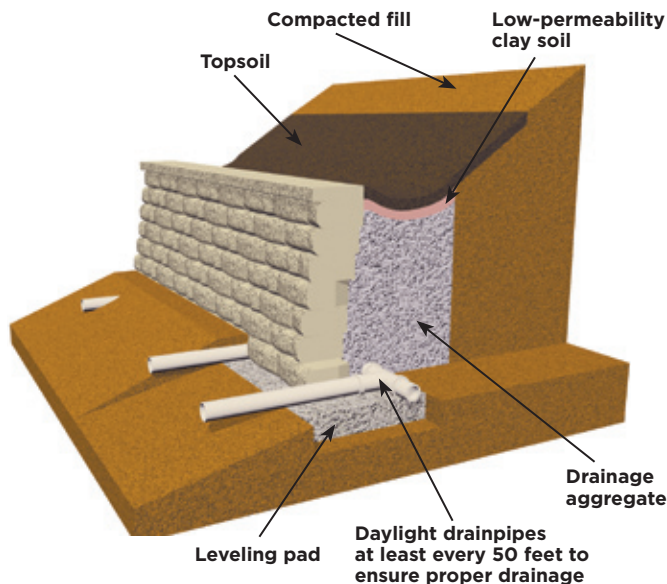

Steps in a 90° Wall

These drawings feature step units. Caps or pavers may be used for treads. Check local building codes for any tread depth standards.

BASE COURSE

Thoroughly compact the leveling pad. Lay out the base course according to the wall design. Place step units first, working from the center to each side. It is very important to backfill and compact behind and along the sides of each course of step units.



Remove lips so walls stack vertically. Glue all units.



FIRST STEP COURSE

Place the first course of step units directly on top of the base course so there is no setback. Stagger them from the previous course and glue in place.



SECOND STEP COURSE

Add the second course of steps, staggering them over the previous course to maintain running bond. Overlap the previous course by 2 inches and glue to the lower course. Place and compact soil fill prior to installing the next course.

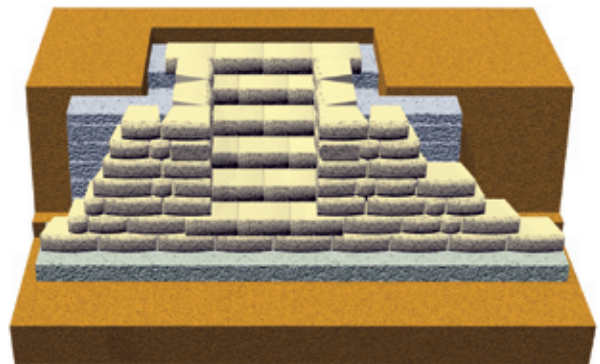

SECOND WALL COURSE

Build the second course of the wall.

THIRD STEP COURSE

Beginning in the center, add the third course of steps, lining up the units with the first course. Overlap 2 inches and glue in place.

ADDITIONAL COURSES

Build the third course of the wall. Repeat wall and step courses until the wall is finished.

Drainage tip: Drainpipe can be placed behind the lowest step units at grade or behind each wall adjacent to the steps.

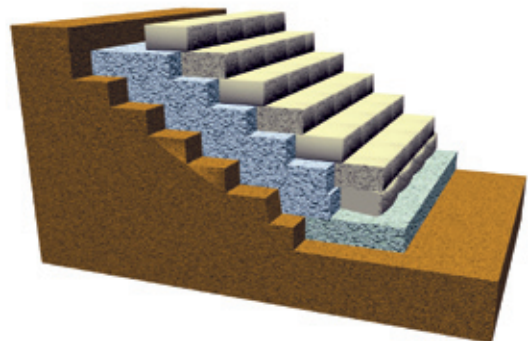

Steps in a Curved Wall

These drawings feature step units. Caps or pavers may be used for treads. Check local building codes for any tread depth standards.

BASE COURSE

Thoroughly compact the leveling pad. Lay out the base course according to the wall design. Place step units first, working from the center to each side. It is very important to backfill and compact behind and along the sides of each course of step units.

FIRST STEP COURSE

Place the first course of step units directly on top of the base course so there is no setback. Stagger them from the previous course and glue in place.

SECOND STEP COURSE

Add the second course of steps, staggering them from the previous course to maintain running bond. Overlap the previous course by 2 inches and glue to the lower course. Place and compact soil fill prior to installing the next course.

SECOND WALL COURSE

Place a block near the second course of steps, maintaining running bond with the base course. Measure and cut a block to fit the space remaining between the step unit and the next course of the wall. Place the unit in the wall, making sure that both vertical edges fit tightly against both the step and standard unit. Remove the rear lip on the blocks when necessary, and angle the blocks flush with the face of the previous course. Glue in place with a concrete adhesive.

ADDITIONAL COURSES

Beginning in the center, add the third course of steps, lining up the units with the first course. Overlap 2 inches and glue in place. Repeat step and wall courses until the wall is finished.

Drainage tip: Drainpipe can be placed behind the lowest step units at grade or behind each wall adjacent to the steps.

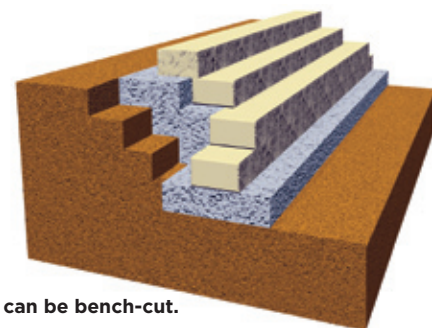
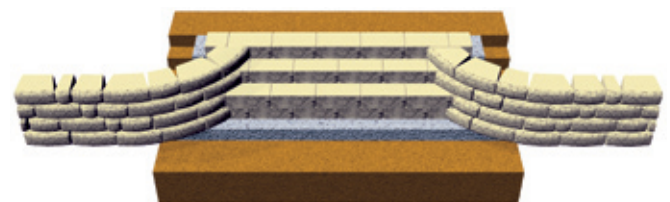
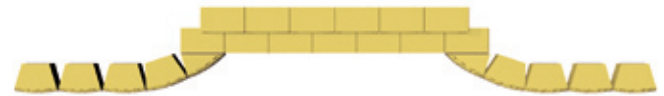

The step can be bench-cut.



CALCULATE THE RADIUS

When building an outside curve, begin by calculating the radius of the top course. This will be the smallest radius in the wall and must not be less than the minimum radius for the block system used.

To calculate the approximate radius of the top course: Add $\frac{1}{4}$ inch to the setback of the block used. Multiply that amount by the number of courses in the finished wall. Then subtract the result from the radius of the base course. This number equals the calculated radius of the top course.

BASE COURSE

Drive a stake into the ground at the desired center of the curve. Attach a string and rotate it in a circle around the stake to mark the radius in the soil. Align the back of the block with the curve and ensure level placement from side to side and front to back.

ADDITIONAL COURSES

On each course, the lip of each block must be in contact with the back of the units below to ensure structural stability. The setback of the block will cause the radius of each course to gradually decrease and eventually affect the running bond of the wall. To maintain proper running bond, use partial units as needed. Once a block is cut to size, glue it in place with a concrete adhesive.

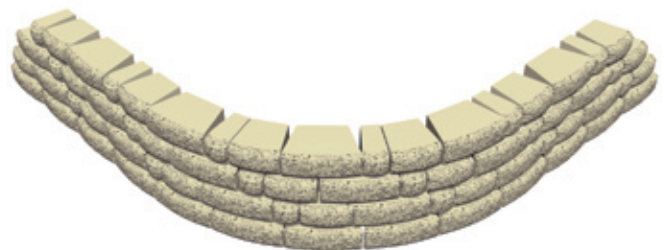
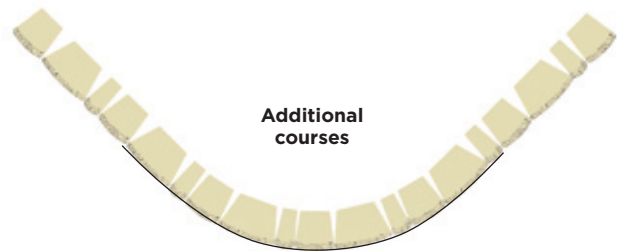
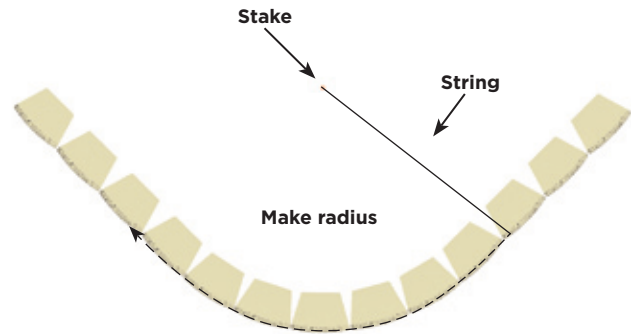

Curving lines add grace and style to any project. See page 12 for information about capping a curve.

Outside Curves with Reinforcement

Most retaining walls are designed assuming 100 percent coverage of the reinforcement. When building an outside curve, the block edges of the reinforcement grid will have gaps so that the back edges don't overlap. In order to ensure 100 percent coverage, additional lengths of reinforcement are used to fill those gaps on the next course of blocks. To prevent slippage, don't overlap the grid on any given course.

FIRST COURSE WITH REINFORCEMENT

Cut reinforcement to the lengths specified in the wall plan. Lay sections of the reinforcement within 1 inch of the face of the wall with the strength direction perpendicular to the wall face. Avoid overlapping the reinforcement by separating each section.

SUBSEQUENT COURSES

Place the next course of blocks, marking their backs to identify unreinforced areas. This step is important because when this course is backfilled, it's impossible to locate the unreinforced areas. Use the marked blocks as a guide, placing subsequent sections of reinforcement to overlap the gaps left on the previous course. This will ensure total reinforcement coverage. Repeat this procedure throughout the construction of the curve when reinforcement is required.

Cut grid to provide as much coverage as possible without overlapping.

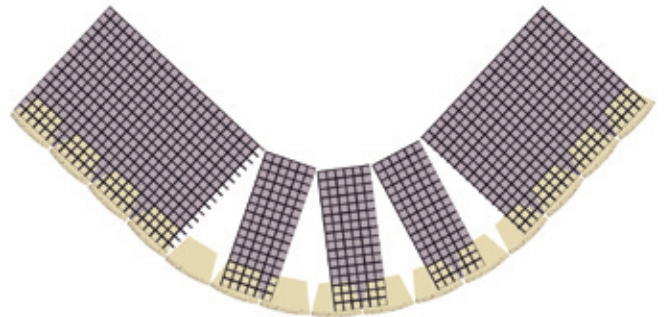

On the second level, fill in the gaps in the first level with strips of geosynthetic reinforcement.

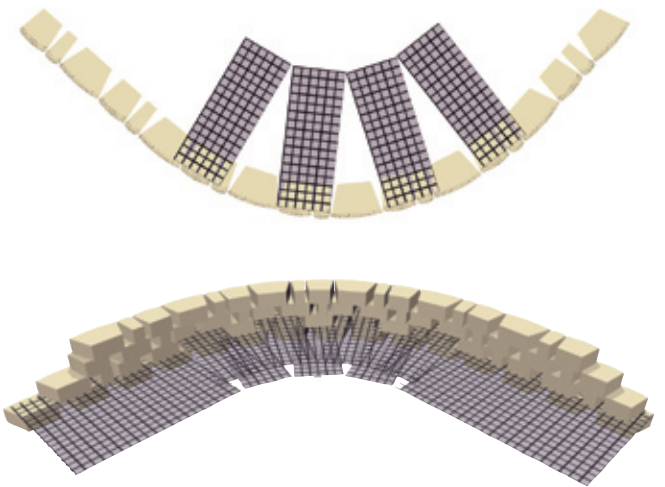

From this viewpoint, it is possible to see the complete grid coverage between the two layers of grid.



Turn an open patio into a cozy corner with curved retaining walls. Wall curves are repeated in the steps.



CALCULATE THE RADIUS

Check the wall plan to determine the radius of the base course. This will be the smallest radius in the wall and must not be less than the minimum for the block system used.

BASE COURSE

Begin by driving a stake into the ground at the desired center of the curve. Attach a string and rotate it in a circle around the stake to mark the radius in the soil. Align each block face with the radius curve and ensure level placement from side to side and front to back.

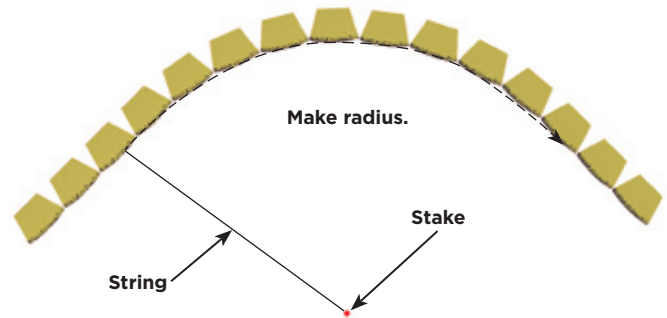

ADDITIONAL COURSES

On each course, the lip of each block must be in contact with the back of the units below to ensure structural stability. The setback of the block will cause the radius of each course to gradually increase and eventually affect the running bond of the wall. To maintain proper running bond, use partial units as needed. Once a split unit is cut to size, glue in place with a concrete adhesive.

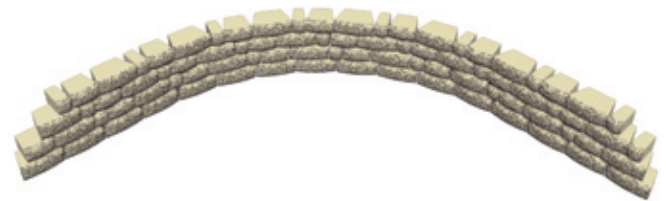

Most retaining walls are designed assuming 100 percent coverage of the reinforcement. When building an inside curve, the back edges of the reinforcement will fan out, producing slight gaps. In order to ensure 100 percent coverage, additional lengths of reinforcement are used to fill those gaps on the next course of blocks. To prevent slippage, don't overlap the grid on any given course.

FIRST COURSE WITH REINFORCEMENT

Cut reinforcement to the lengths specified in the wall plan. Lay segments of reinforcement within 1 inch of the face of the wall, making sure that the strength direction of each section is perpendicular to the wall face. Avoid overlapping the reinforcement by separating each section.

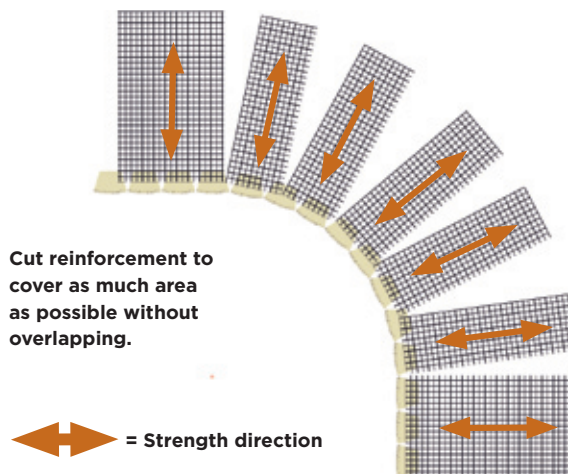

SUBSEQUENT COURSES

Place the next course of blocks, marking their backs to identify unreinforced areas. This step is important because when this course is backfilled, it's impossible to locate the unreinforced areas. Use the marked blocks as a guide, placing subsequent sections of reinforcement to overlap the gaps left on the previous course. This will ensure total reinforcement coverage. Repeat this procedure throughout the construction of the curve when reinforcement is required.

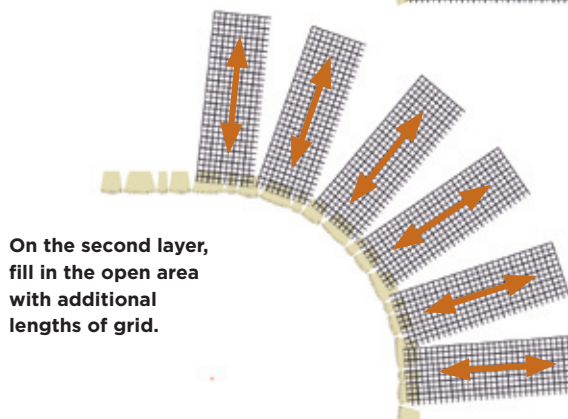

BASE COURSE

To build an outside 90° corner, begin by splitting* a large block in half. Place this block with both split faces outward at the corner. Remove the rear lip so that the block lies flat. Then lay the rest of the base course working from the corner block out.

ADDITIONAL COURSES

Begin the second course with the other half of the large block. Place the second and third blocks on either side of the corner block. Once the corner block is in position, glue it in place with a concrete adhesive. Continue to alternate the corner block orientation with each course and always use a concrete adhesive.

**To split a block, use a hydraulic splitter or split manually by using a hammer and chisel to score the block on all sides. Pound the chisel on the same line until the block splits. If partial unit sides are not exposed, use a circular cut-off saw with a masonry blade to achieve a tighter fit.*

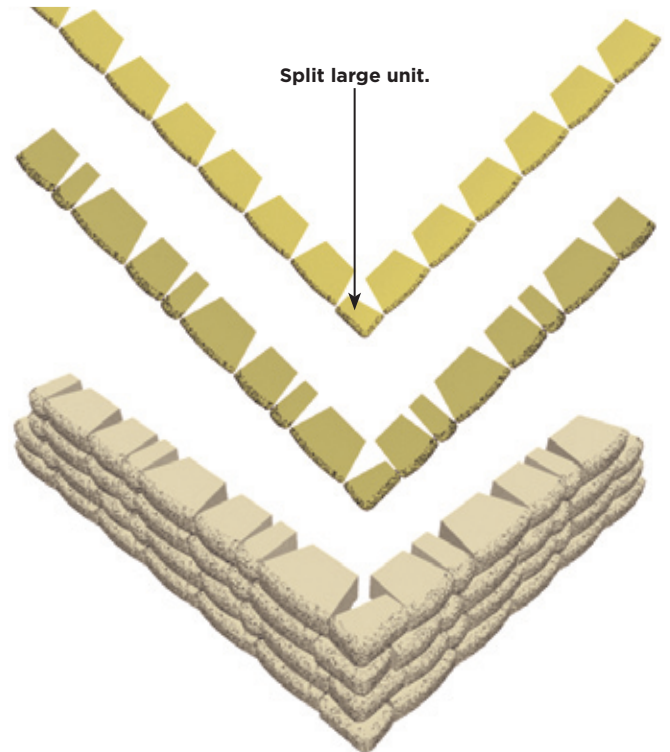

FIRST COURSE WITH REINFORCEMENT

Begin by checking the wall plan to determine reinforcement lengths and elevations. Lay a section of reinforcement near the corner of the wall, ensuring that it's placed within 1 inch of the face of the block and running along the back of the adjoining wall.

SUBSEQUENT COURSES

Lay the next course of block, backfill and compact. When installing the next section of reinforcement, place within 2 inches of the face of the block and running along the back of the adjacent wall.

There is compacted backfill between grid layers.

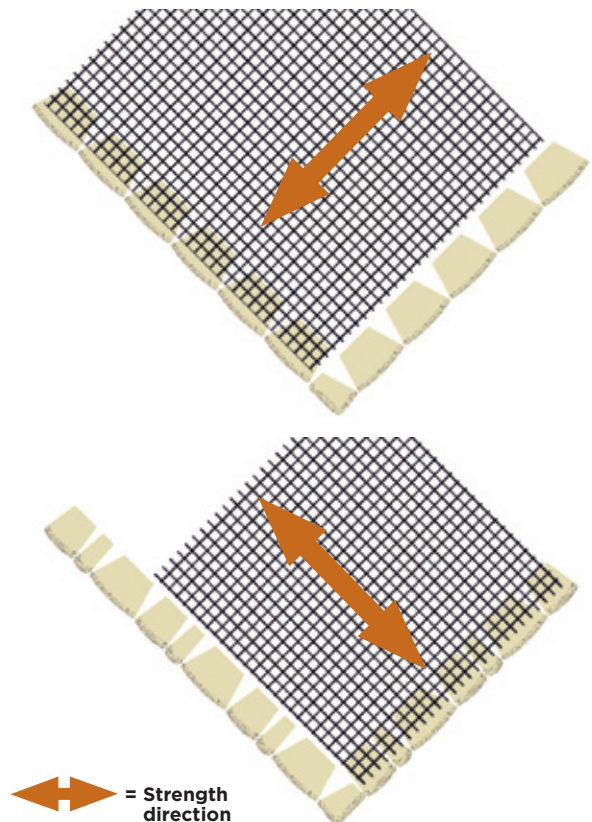
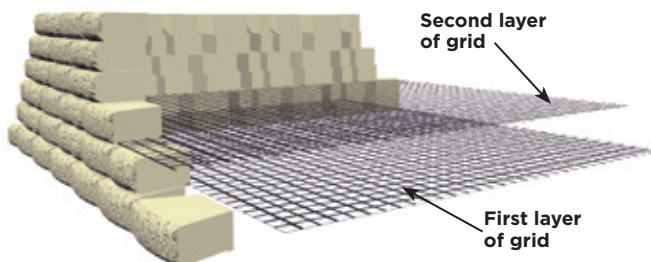

Inside 90° Corners

BASE COURSE

To create an inside 90° corner, begin by placing a block at the corner. Then lay a second block perpendicular to the first and continue laying out the rest of the base course working from the corner out. Remove the rear lip so the block lies flat. Make sure to construct the base course according to standard site prep and installation procedures described earlier.

ADDITIONAL COURSES

On the second course, place all blocks on bond along one side of the corner. Once the second course of one wall is established, begin the second course of the adjacent wall.

Block placement in the corner should alternate direction with each succeeding course.

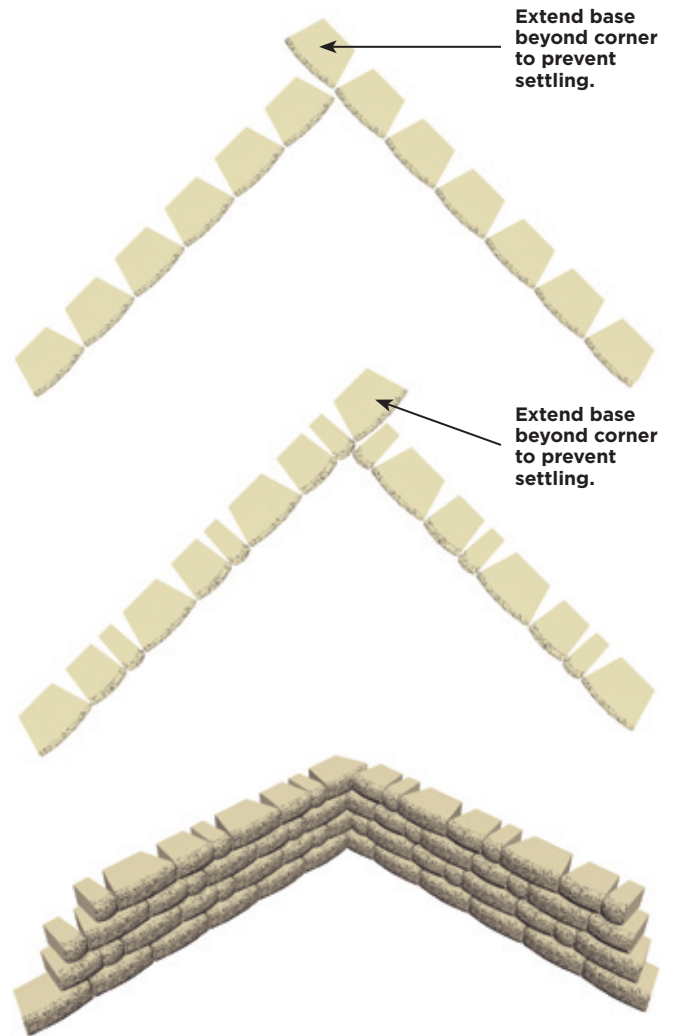

A quiet corner is sheltered with an inside 90° corner built with the Highland Stone® retaining wall system. Step up the caps in 3-inch increments for a finished look.

Inside 90° Corners with Reinforcement

FIRST COURSE WITH REINFORCEMENT

Begin by checking the wall plan to determine reinforcement lengths and elevations. Cut reinforcement to the lengths shown in the wall plan, paying attention to the reinforcement strength direction.

Next, determine the proper placement of the reinforcement grid by dividing the proposed height of the wall by four. This represents the distance that reinforcement should extend beyond the front of the adjoining wall. Measure this distance from the front of the adjoining wall, begin the grid placement here. Make sure the grid is placed within 1 inch of the face of the wall and runs along the back of the adjoining wall.

Example: If overall wall height is 8 feet, the reinforcement extension would be 2 feet.

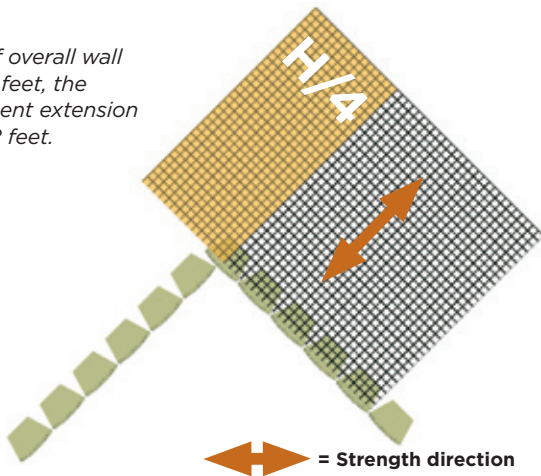

Place the next section of reinforcement on the adjoining wall. The reinforcement should not overlap and should lie flush with previously placed sections. Once reinforcement is in place, the next courses of block can be installed.

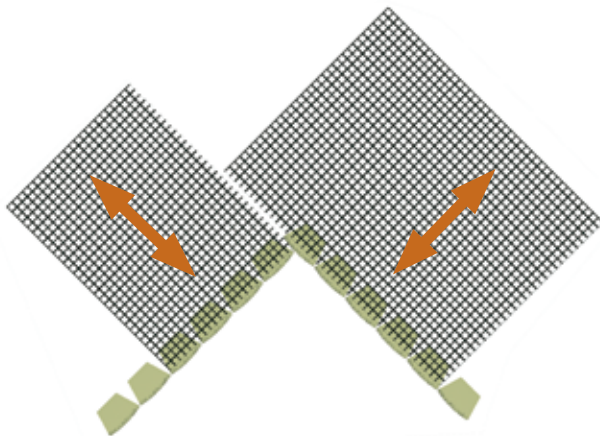

SUBSEQUENT COURSES WITH REINFORCEMENT

The first section of grid on these courses is placed using the same formula that determines placement in front of the adjoining wall.

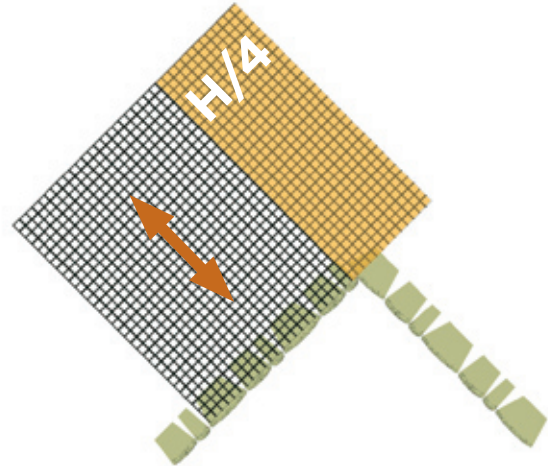

Alternate the reinforcement extension on each course where reinforcement is required.

Place the next section of reinforcement on the adjoining wall. The reinforcement should not overlap and should lie flush with previously placed sections. Once reinforcement is in place, the next courses of block can be installed.

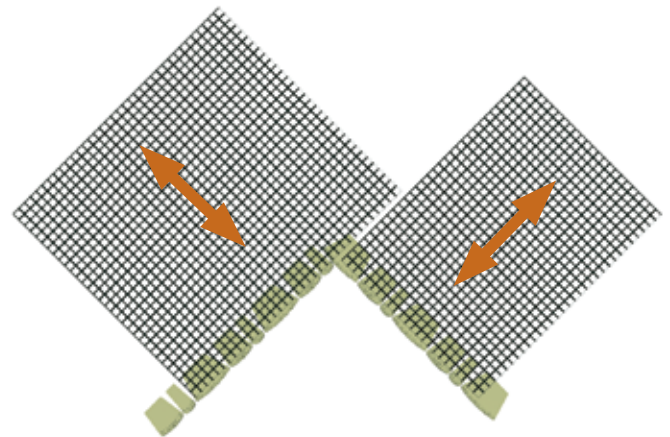

With correct design and construction, Anchor™ products can be successfully installed at the edge of water channels, river banks and drainage ditches.

The final design of the wall is affected by various factors, including the movement and velocity of the adjacent water, erosion and scour, the direction of water travel to the wall, the risk of flooding, as well as the soil and ground conditions where the wall is being built.

A qualified engineer should always be consulted to determine the effect of water on the wall and to design a wall that takes all these factors into account.

Consult a qualified engineer before design, construction and installation take place, and follow the engineer's design.

BASE COURSE

Place a filter fabric with extra length in front of the wall.

Install the leveling pad and the base course of block, including drain tile and drainage aggregate. Wrap the extended filter fabric up along the face of the base course. Place soil fill in front of the wall and compact. Install another section of filter fabric in front of the wall to protect against erosion. Cover the fabric with a minimum of 3 inches of sand. Install larger stones, such as riprap, to hold it in place.

NEXT COURSE

Continue constructing the wall. Drainage is vital. To prevent clogging of the drainage aggregate and drainpipe by fine-grained soils, a geosynthetic filter fabric is installed to separate the drainage aggregate from the reinforced soils.

ADDITIONAL COURSES

Continue these steps until the wall is complete. The last section of filter fabric should cover the drainage aggregate and run up against the back of the top course of block. Add fill soil and compact.

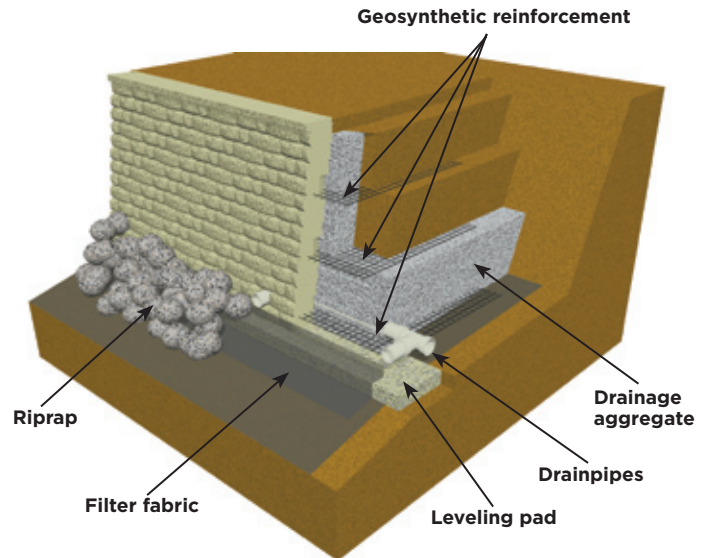

Water applications are a great way to get more use from a property.

INDEPENDENT TERRACED WALLS

For each wall to be independent of others, it must be built using a 2:1 ratio – the upper wall must be built a distance away from the lower wall of at least twice the height of the lower wall. In addition, the upper wall must also be equal to or less than the height of the lower wall. Exceptions to this general rule include weak soil conditions or where slopes exist above, below or between wall locations. For example, if the lower terrace is 4 feet tall, the distance between the terraces must be at least 8 feet and the upper wall must not be higher than 4 feet.

Drainage is vital to maintaining stable, long-lasting terraced walls. Drainpipe must be installed so that the water is directed around or under the lower wall (never place the drain outlet for the upper wall above or behind the lower wall).

For more detailed information about drainage, see Daylighting and Drainage Swales on page 13.

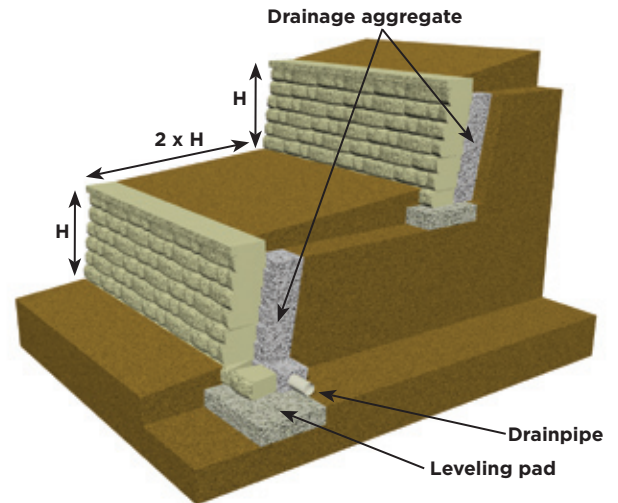

DEPENDENT TERRACED WALLS

When the distance between the lower and upper walls is less than twice the height of the lower wall, the walls become structurally dependent on each other. In this situation, it is important to take global stability into account, incorporating additional reinforcement – and longer layers – into the wall plan. In addition, structurally dependent walls require even more excavation, backfill and time. So plan ahead. Be sure to check the wall plan for specific requirements. For structurally dependent walls, consult with a qualified engineer.

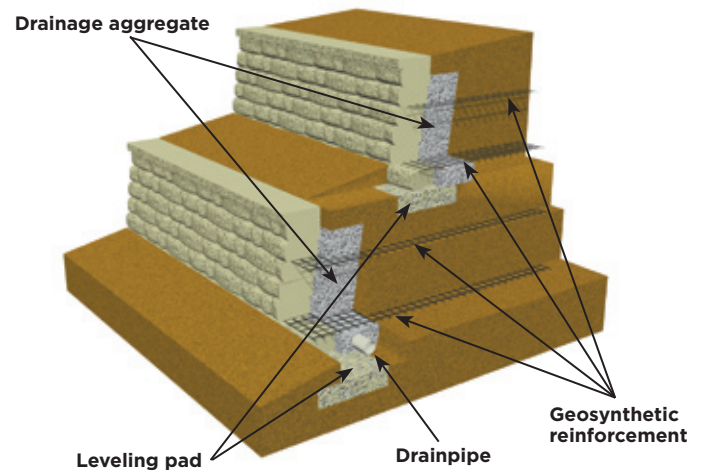

FENCES

Know the dimensions of the fence to determine the placement of the sleeves. Provide at least 1 inch clearance between the inside of the sleeve and the outside of the post, and allow for mortar and grout. Install the sleeves according to the wall plan during the construction of the wall.

If the fence is at least 3 feet behind the wall, generally no additional reinforcement is required. If the fence is installed within 3 feet, there may be some load transferred to the wall from wind, snow or pedestrians. Additional reinforcement around the fence sleeves may be needed.

Grout the fence post into the sleeve after the wall is built.

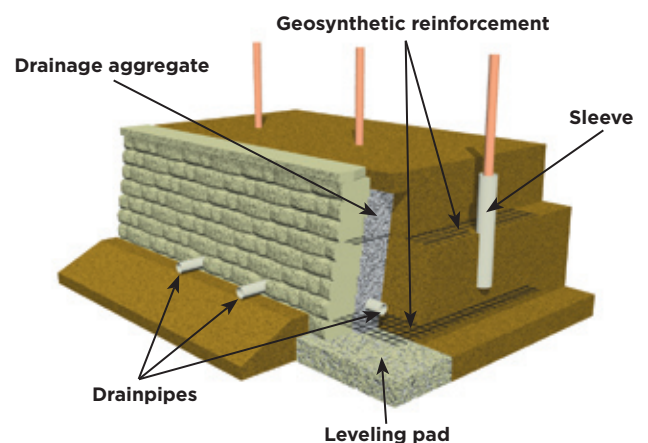

Tip: Visit www.fencesleeve.com for information about sleeves.

Multipiece Wall Systems



© 2011 Anchor Wall Systems, Inc. The "Anchor A" and "Anchor Build Something Beautiful" logos, "Anchorplex" and "Sequent" are trademarks of Anchor Wall Systems (AWS). These wall systems are covered by the AWS Limited Warranty. For a complete copy, visit your local dealer or see anchorwall.com.

Anchor Wall Systems, Inc., 5959 Baker Road, Suite 390, Minnetonka, MN 55345.
A&B1106

72.3288.1 01/12 4012